

Vada Volaterrana: gli horrea

Strutture, stratigrafie, materiali

A cura di
Simonetta Menchelli, Marinella Pasquinucci, Paolo Sangriso

Matrix



Matrix a cura di Paolo Sangriso

Legenda

Rosso	Strutture/elementi strutturali
Rosa	Cocciopesto
Grigio	Sabbia
Verde	Battuti pavimentali
Celeste	Tagli
Viola	Preparazioni sottopavimentali
Marrone	Laterizio
Marrone chiaro	Palificazione lignea
Verde	Piombo
Blu	Strati di malta
Bianco	Strati a matrice argillosa

Nei diagrammi i numeri romani indicano le fasi del periodo 2 mentre i numeri arabi i periodi 1, 3 e 4 che non hanno fasi.

Saggio I (*Horrea*, Ambiente 2)

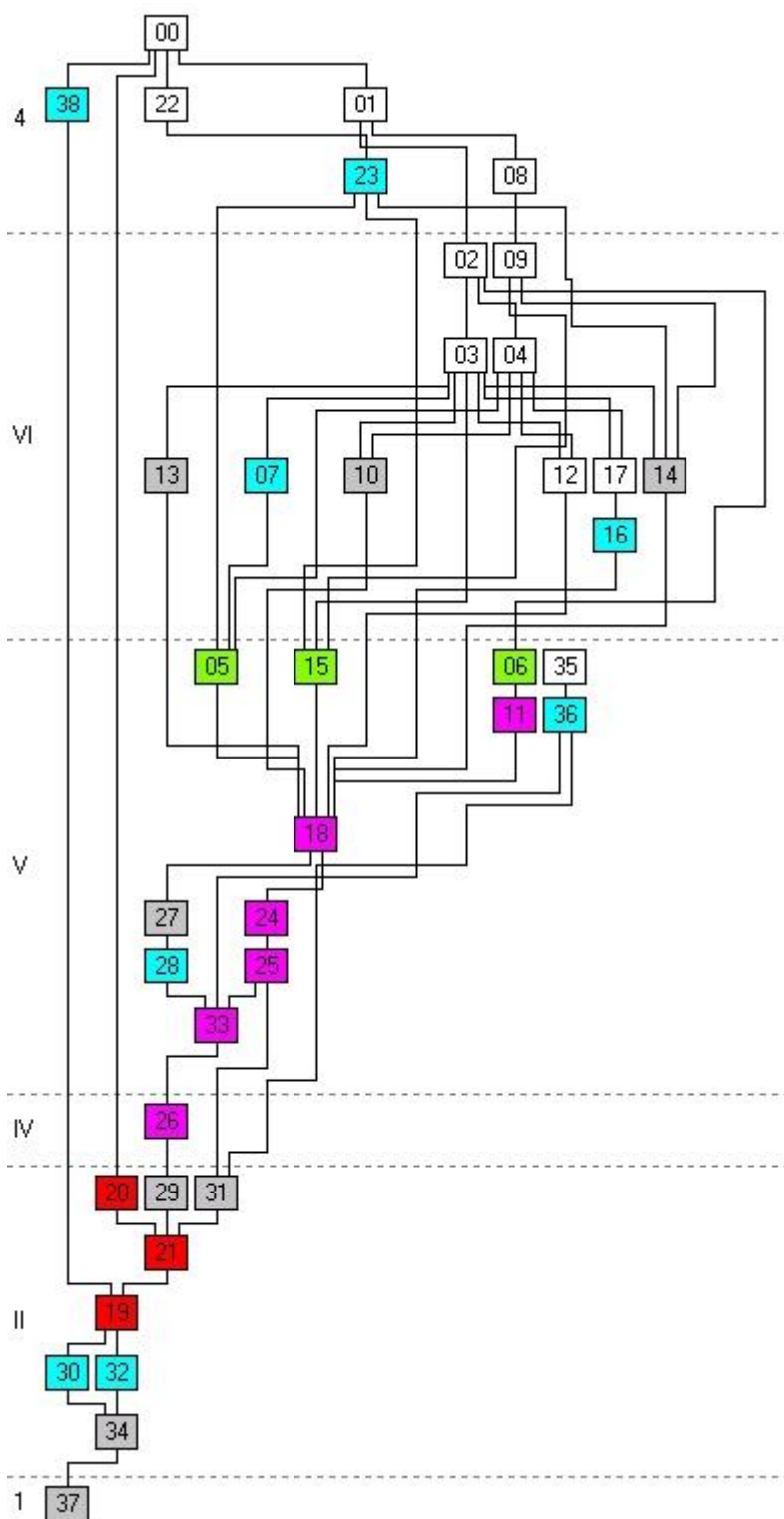

Saggio II (*Horrea*, Ambiente 3)

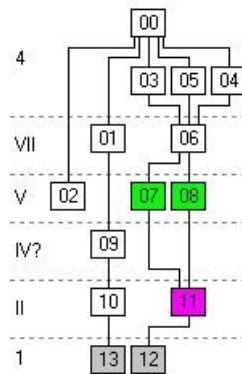

Saggio II Ovest (*Horrea*, Ambiente 3)

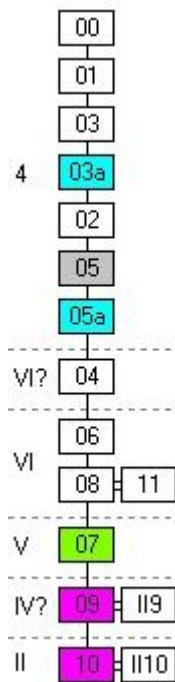

Saggio III (*Horrea*, Ambienti 4 e 5)

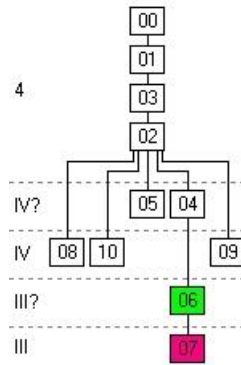

Saggio IV ampliamento Nord (*Horrea*, Ambiente 2 ed esterno)

Sono indicate solo le UUSS di pertinenza dell'Ambiente 2

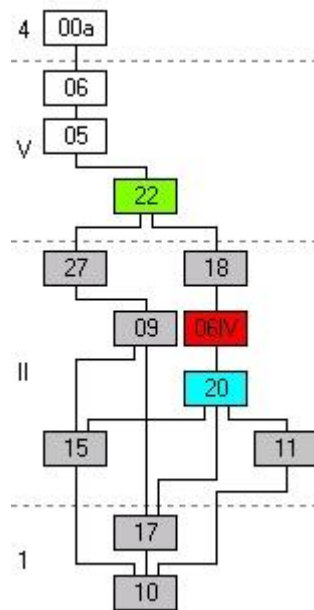

Saggio IV (*Horrea*, Ambienti 1 e 2)

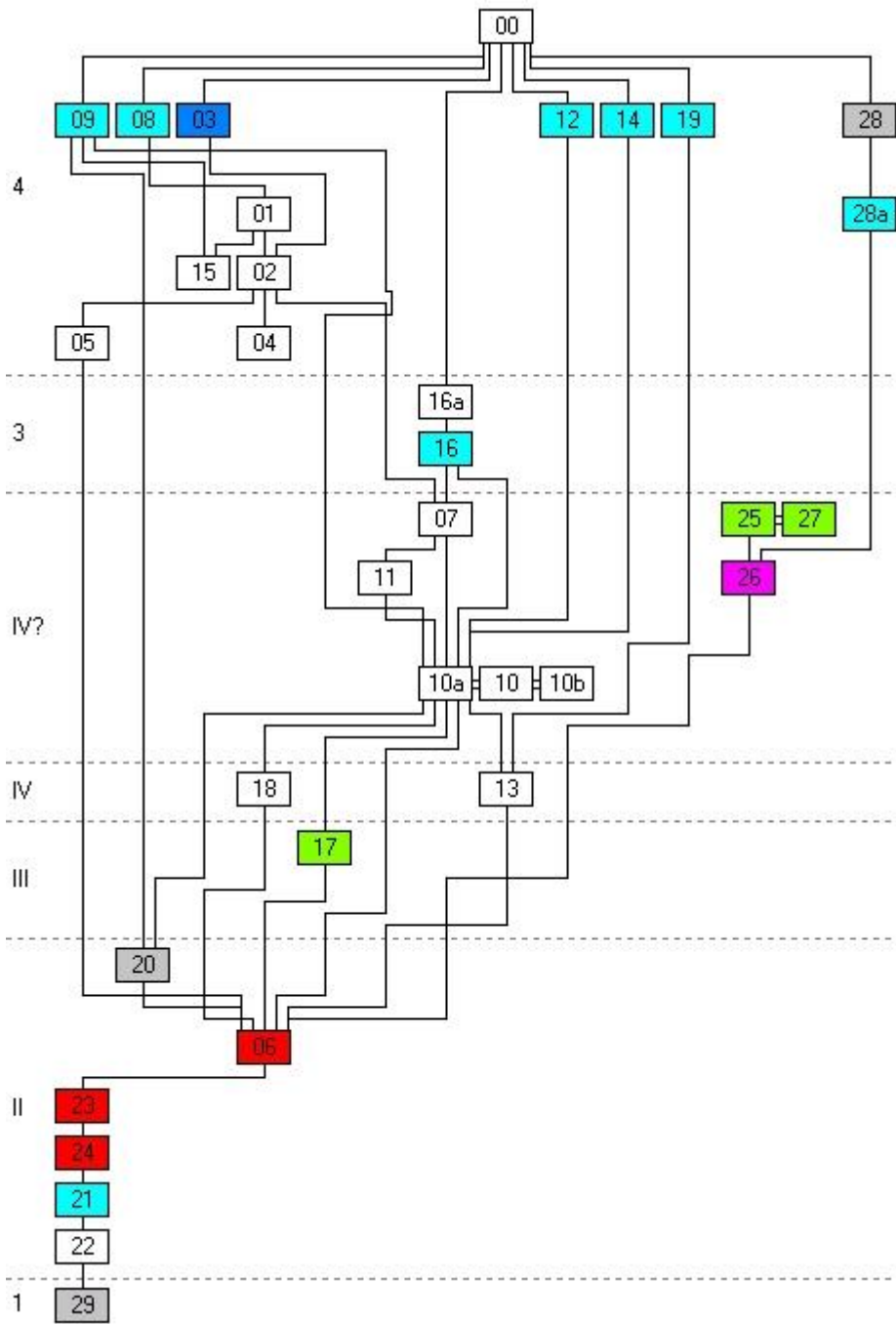

Saggio Va (*Horrea*, Ambiente 2, esterno)

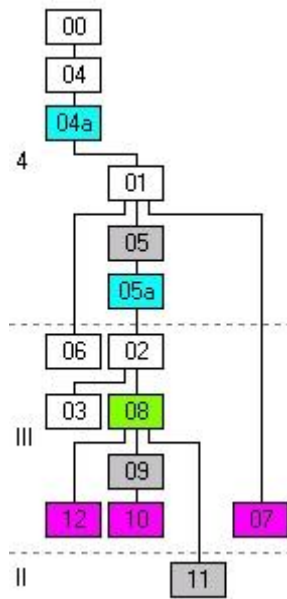

Saggio VI (*Horrea*, Ambiente 2)

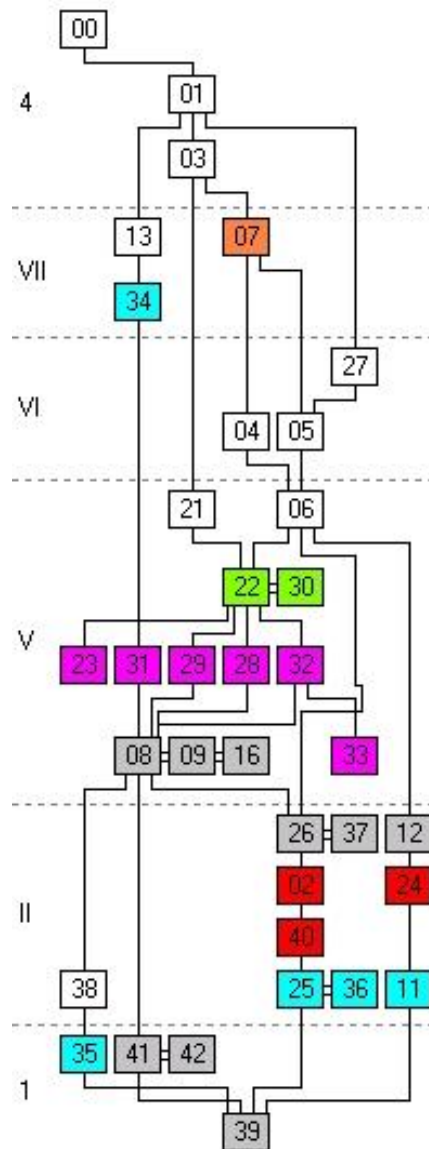

Saggio VI Est (*Horrea*, Ambiente 2, esterno orientale)

Sono indicate solo le UUSS di pertinenza dell'Ambiente 6

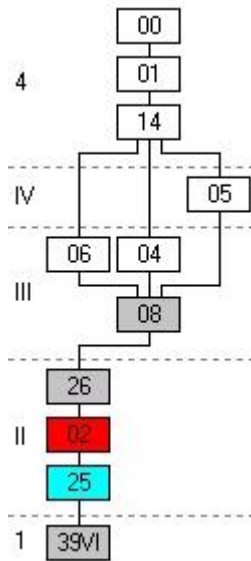

Saggio VII (*Horrea*, Ambienti 13 e 14)

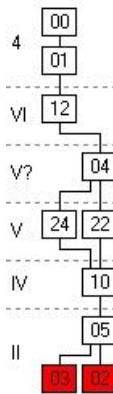

Saggio VIII (*Horrea*, Portico ambienti 3, 4 e 5)

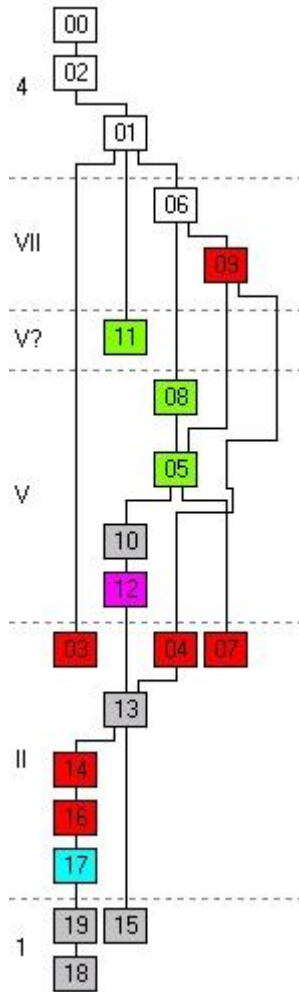

Saggio IX (Collettore A, esterno Ovest Ambiente 6)

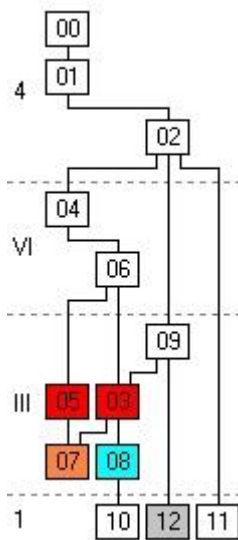

Saggio X (Collettore A, esterno Sud Ambienti 12 e 14 delle Piccole Terme)

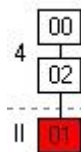

Saggio XI (*Horrea* Ambienti 2, 3 e 4)

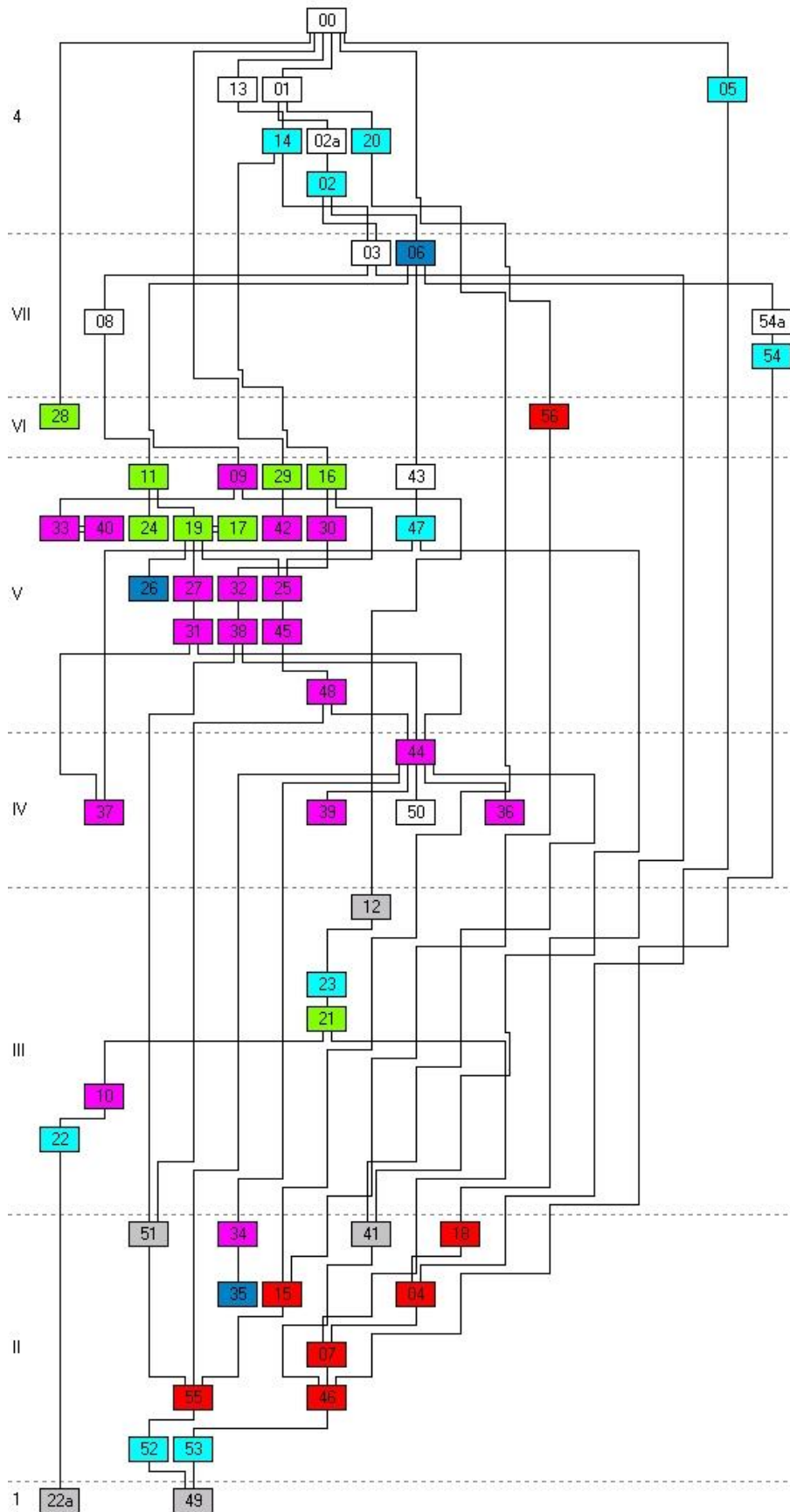

Saggio XII (*Horrea Ambiente 1*)

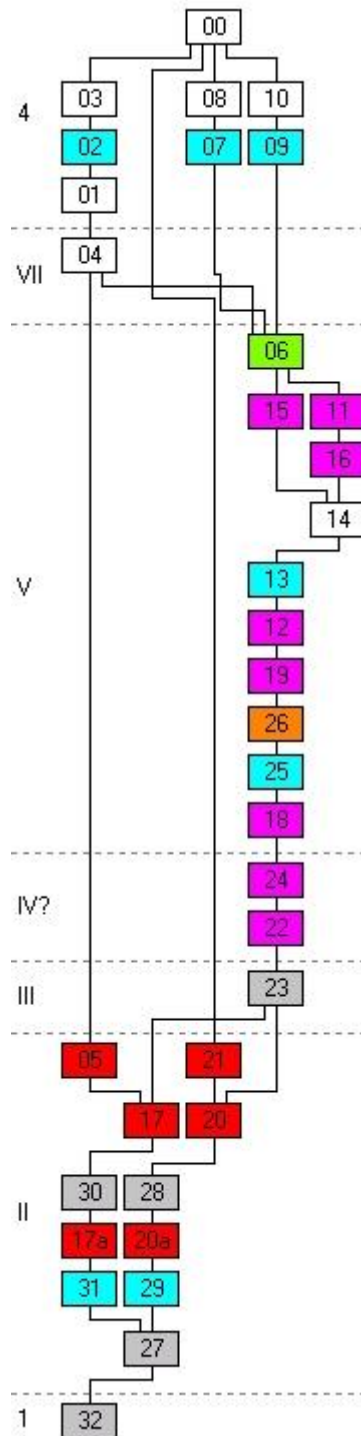

Saggio XIII (*Horrea*, Perimetrale Sud, Ingresso)

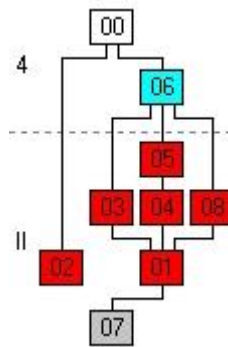

Saggio XIV (*Horrea*, Ambiente 1 ed esterno)

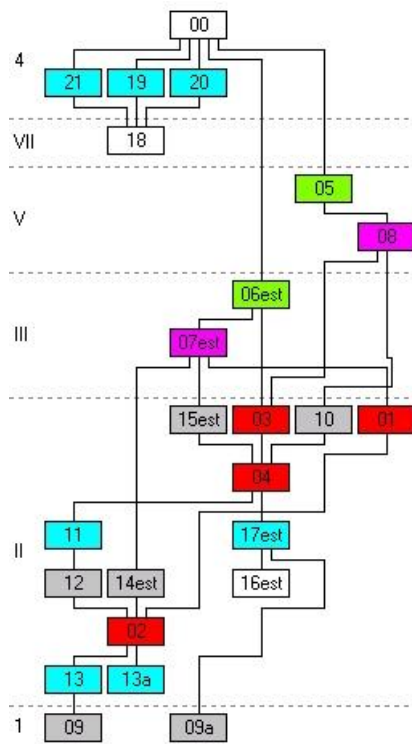

Saggio XV (*Horrea*, Ambiente 36)

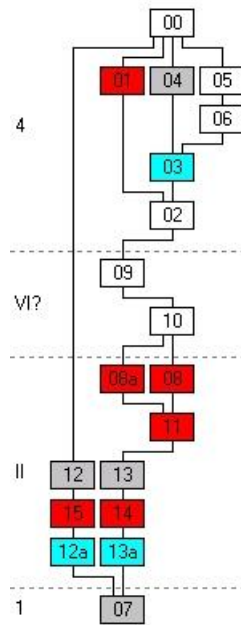

Saggio XVI (*Horrea*, Ambiente 36 ed esterno Est)

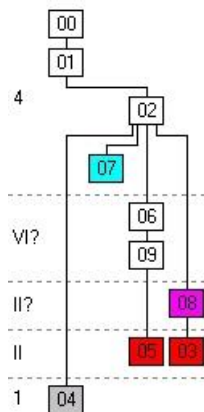

Saggio XVII (*Horrea*, Ambiente 1)

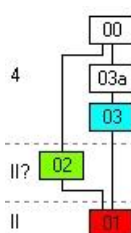

Saggio XVIII (*Horrea*, Ambiente 28)

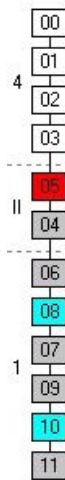

Saggio XIX (*Horrea*, Ambienti 34, 35, e 36)

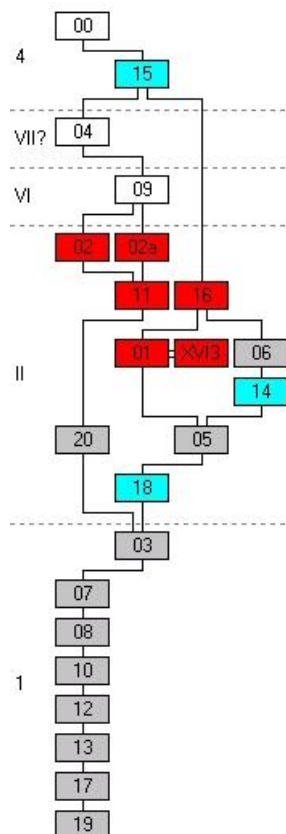

Saggio XX (*Horrea*, Ambienti 28 e 29)

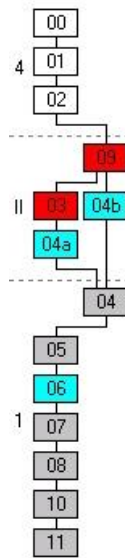

Saggio XXII (*Horrea*, Portico Ambiente 28)

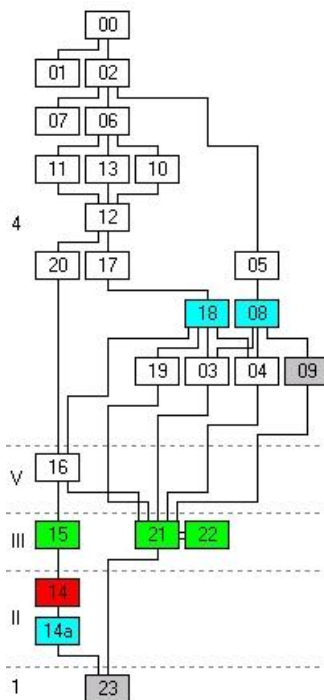

Saggio XXIII (*Horrea*, Portico Ambienti 13, 14 e 15)

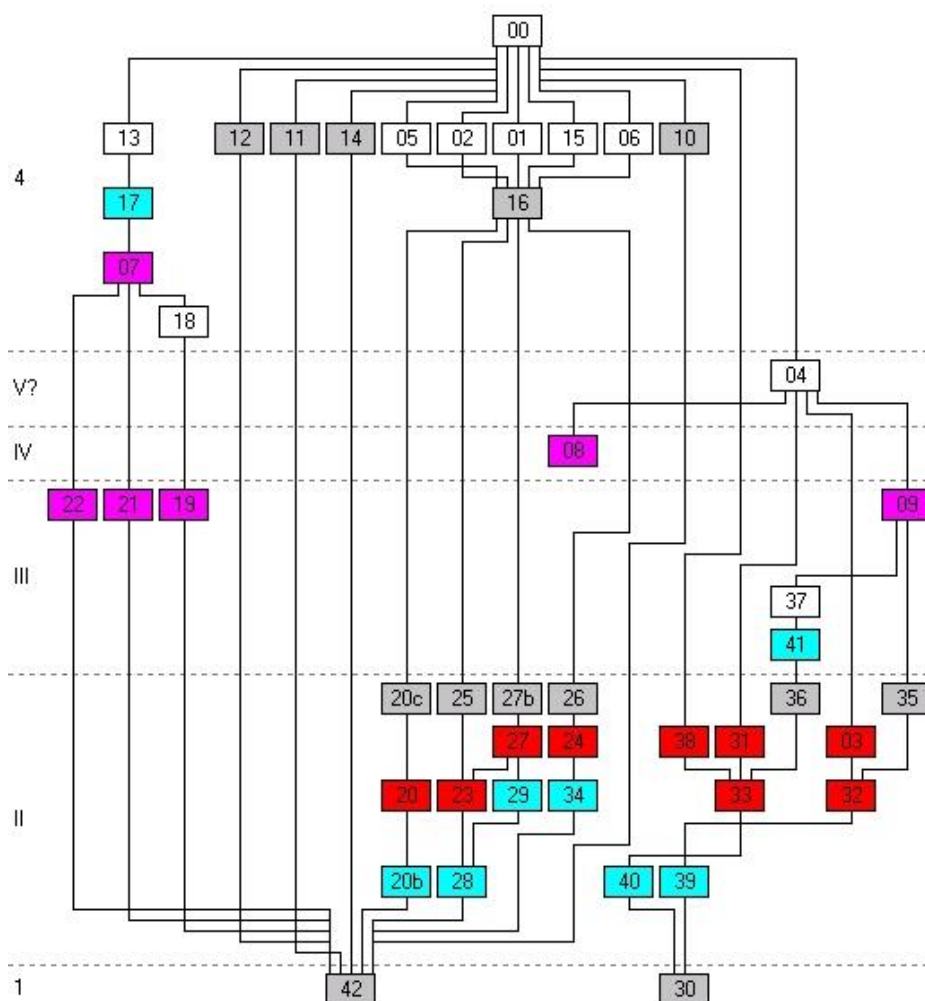

Saggio XXIV (*Horrea*, Ambienti 31, 32, 33 e 34)

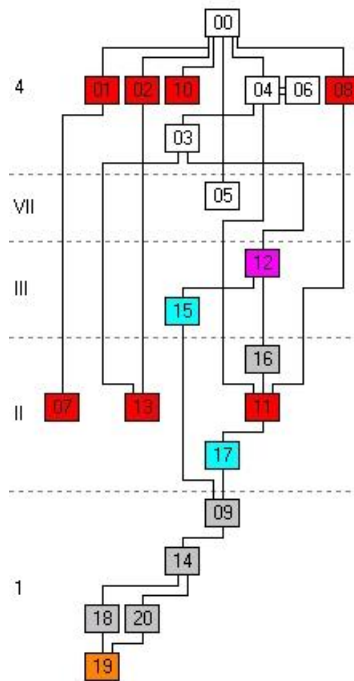

Saggio XXV (*Horrea*, Ambienti 15 e 16)

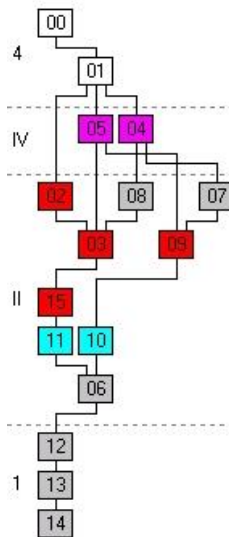

Saggio XXVII (*Horrea*, Ambienti 34 e 35)

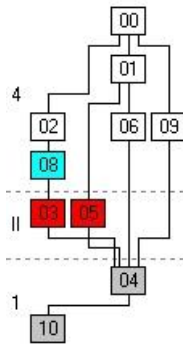

Saggio XXVIII (*Horrea*, Ambienti 14, 15 e 16)

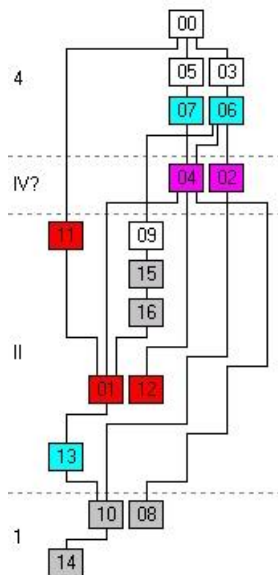

Saggio XXIX (*Horrea*, Ambienti 33 e 34)

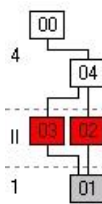

Saggio XXXIII (*Horrea*, Ambiente 35)

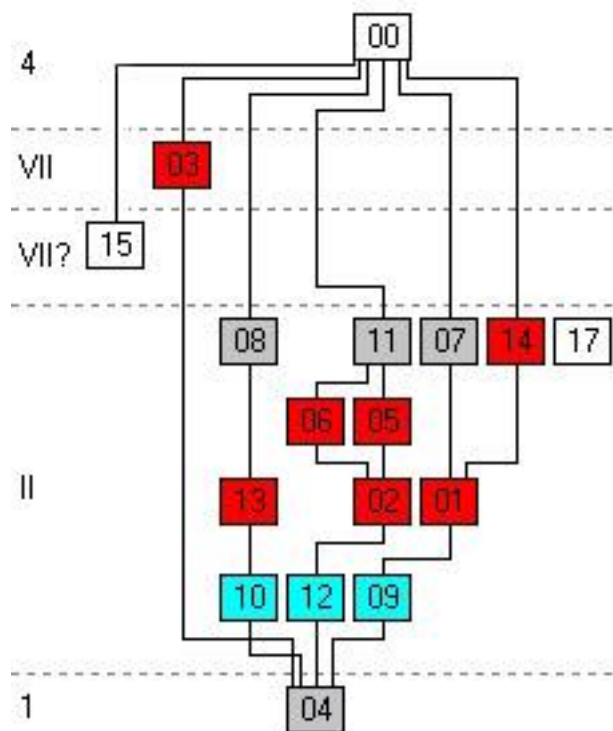

Saggio LXIX (Fontana, vasca semilunata e Grandi Terme, *caldarium*)

Sono indicate solo le UUSS di pertinenza della Fontana

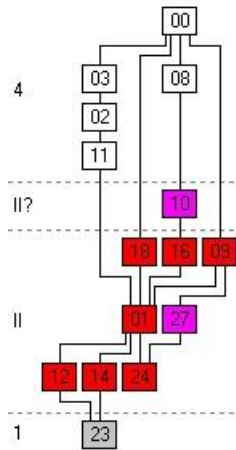

Saggio LXXV (Fontana, vasca quadrangolare)

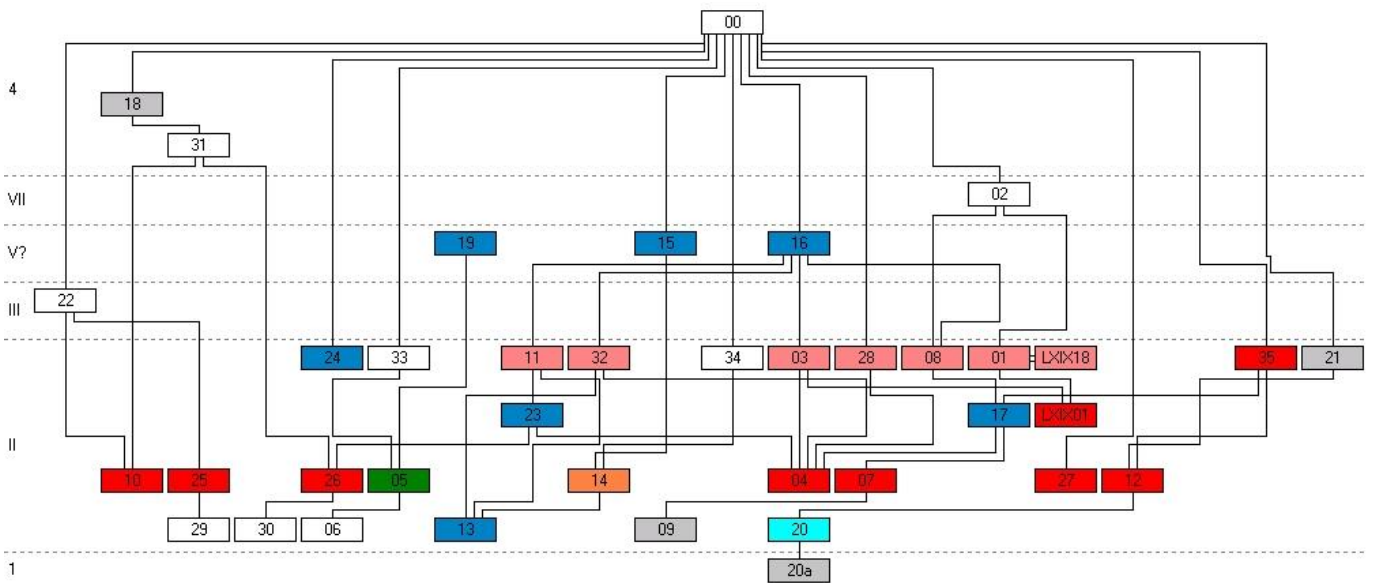

Ambiente III (Piccole Terme, *prae-furnium*)

